

Happy D.2 Plus

HP 4388

Monteringsvejledning

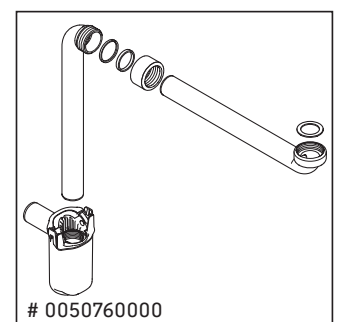
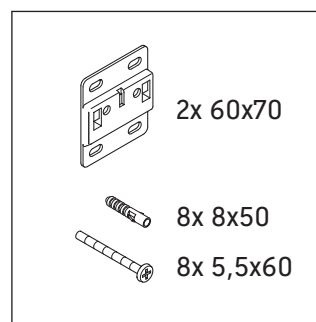
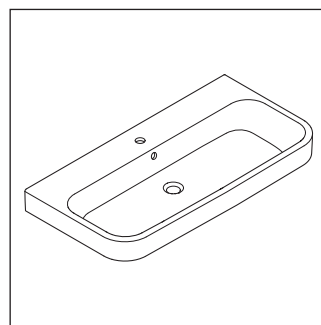
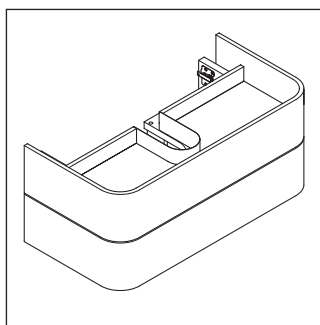
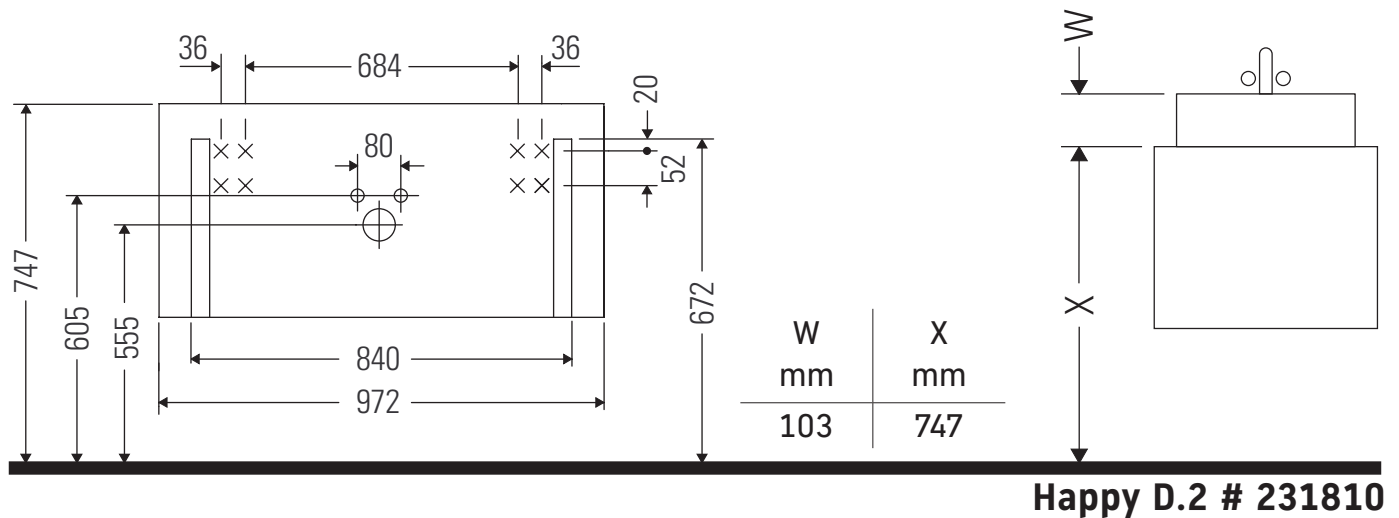

Brugsanvisninger

Badeværelsesmøblerne er på tidspunktet for leveringen i overensstemmelse med gældende normer og retningslinjer og er designet til brug i badeværelser. Direkte fugtning med vand, f.eks. ved brusebad, bør undgås.

Vi forbeholder os ret til tekniske forbedringer og ændringer af de viste produkter.

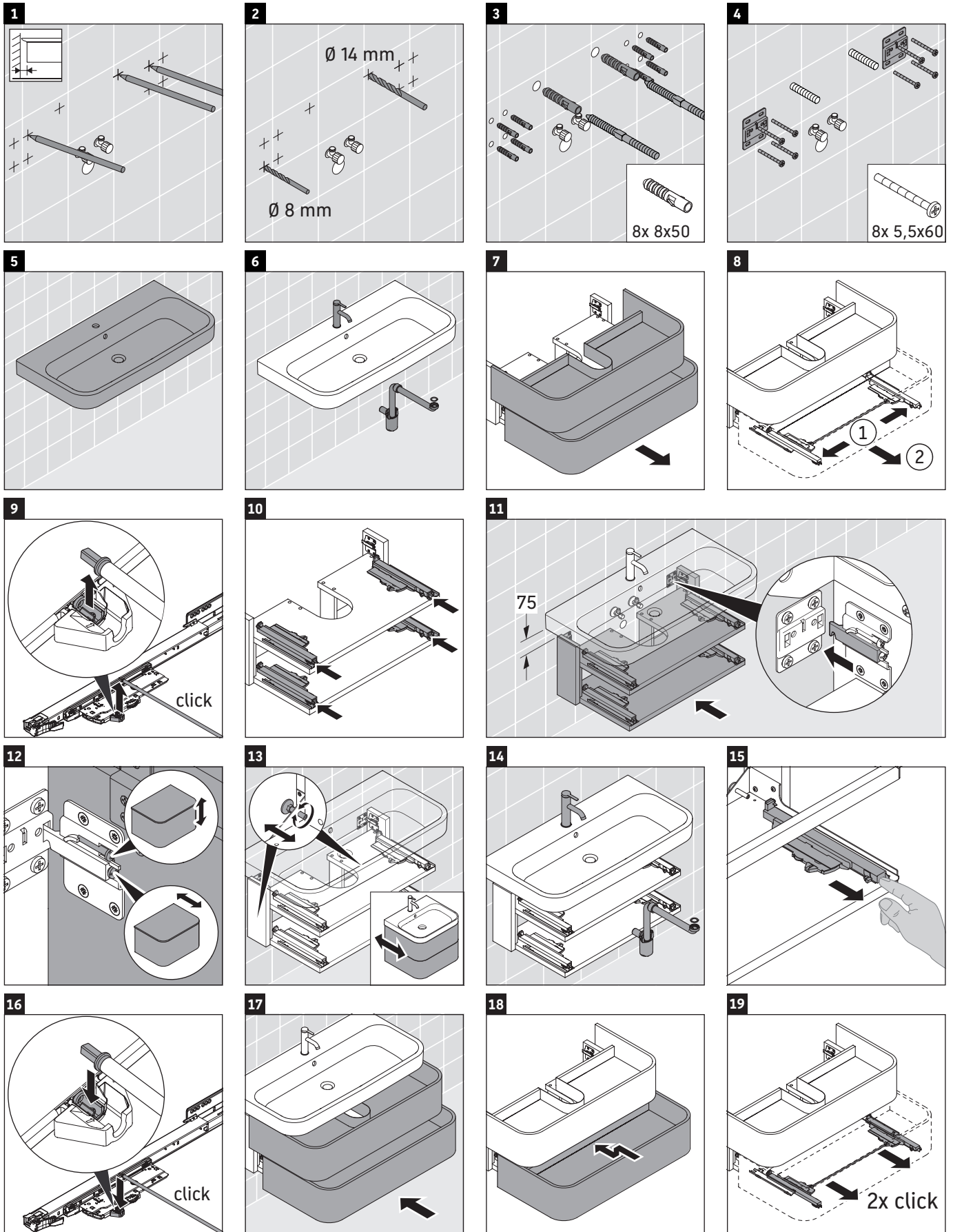

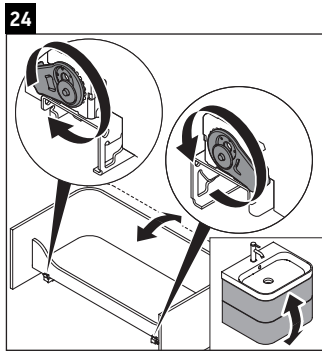
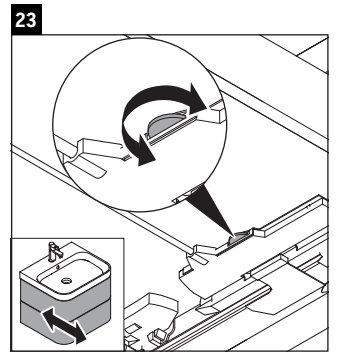
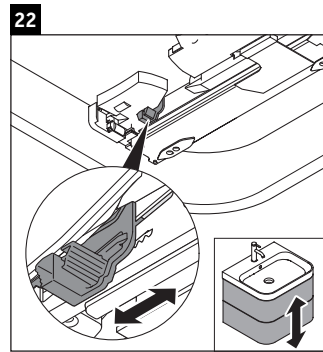
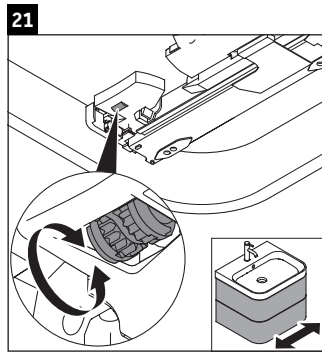
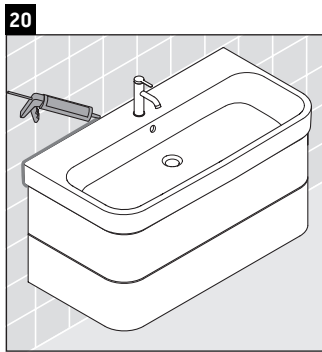

Duravit AG
P.O. Box 240
Werderstr. 36
78132 Hornberg
Germany
Phone +49 78 33 70 0
Fax +49 78 33 70 289
info@duravit.com
www.duravit.com



Order no. HP4388/22.01.1